

THEREC CORPORATION LTD.

Rotary and Diverter Valve (European best seller valve)

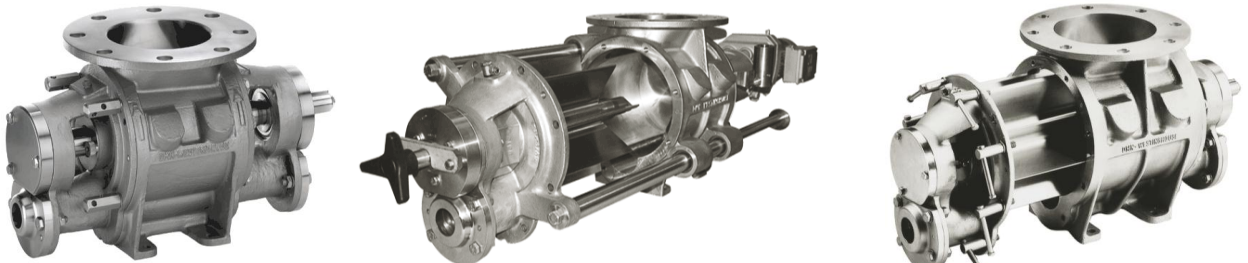

Drop Through Rotary valve / normal , quick detachable Food and dairy valve type



Blow Through Rotary valve / normal , quick detachable and dairy valve type

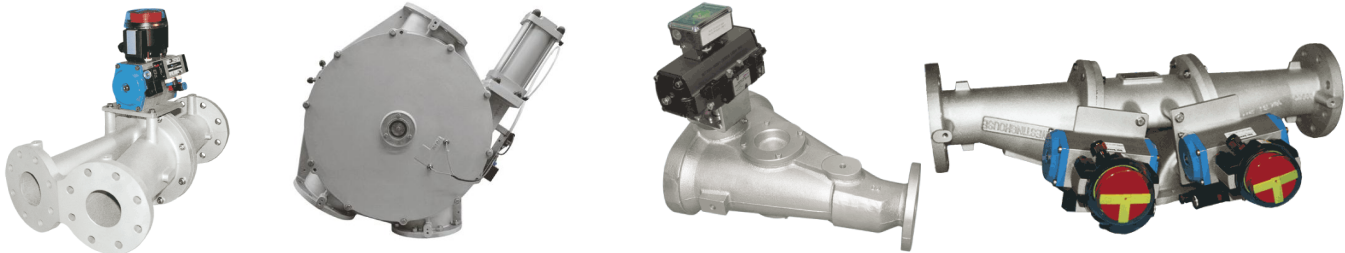

Diverter valve / Flap type , Plug type , Hammer type and Fill Vent valve



Diverter Valve Multi-port Type / USDA approved Diverter Valve, Plug & Ball Type for CIP



Sanitary(Medicine) Type Rotary valve



CIP suitable Type Rotary valve



RID Rotor conference detection



ATEX 94/9/EC
Is available on
requested

www.thereccorp.com

Bulk material Handling Valve & Accessories



Silo feeding Multi ways diverter valve

Cast iron and Stainless steel Slide gate valve



Aluminium Butterfly valve

Pinch valve

Silo pressure & vacuum valve

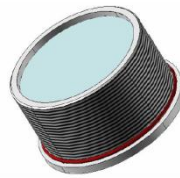
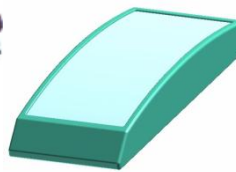

Vibrofluidizer

Fluidification plate PF & FLUO

Air knocker

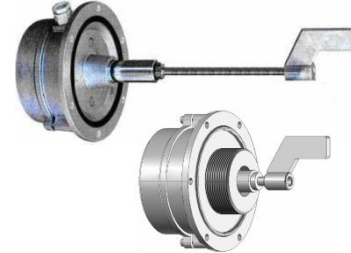

Conveying Eductor

Wear Resistant Bends

Level sensor



Our Quality Commitment



Pneumatic conveying pipe compression coupling and sight glass

www.thereccorp.com

Bulk material Handling Accessories



Diverter valve



Cipriani Harrison Valves Pvt. Ltd.



Standard Sight Glass



Guarded Sight Glass

Sight glass



Seeflex Regulations - EC, FDA, USDA, 3A

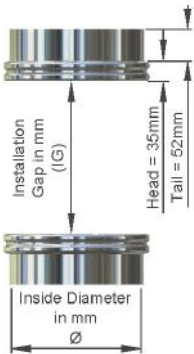

In-line static equipment
IG = CL - 10mm
(Minimum)



Off Set equipment
IG = CL - 20mm
(Minimum)

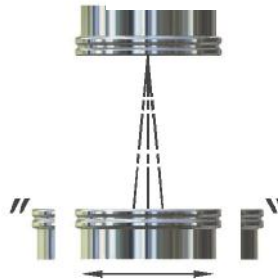

Oscillating equipment
IG = CL - 40mm
(Minimum)

FROM THIS....



UNTIDY

DIFFICULT TO FIT

PRODUCT BUILD UP ISSUES

TO THIS....



TIDY

EASY TO FIT

ELIMINATES ALL PRODUCT BUILD UP



Flexible Hose • Ducting • Accessories

Flexible hose for air, gas and bulk material transferring

QUALITY HOSES
FOR OVER 65 YEARS

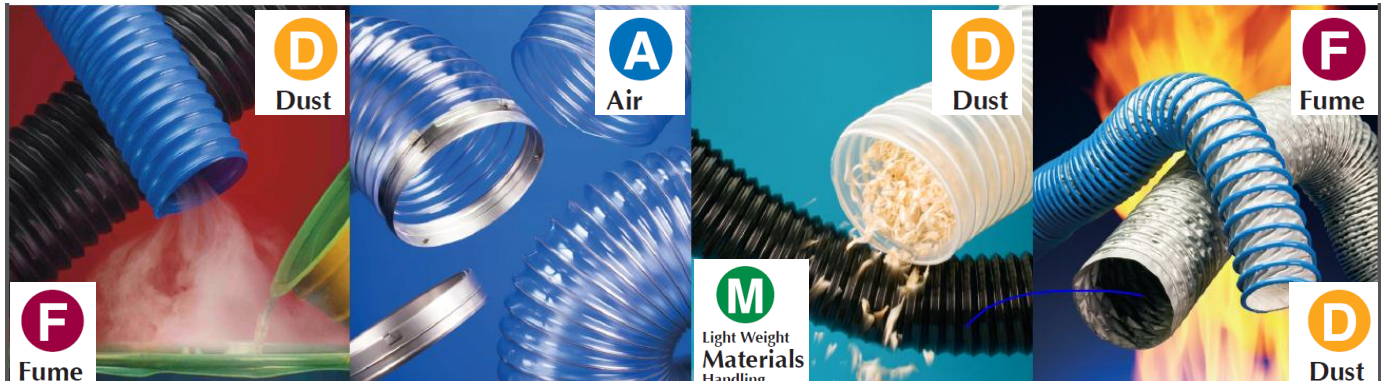

Dust Explosion Protection Equipment

VIGILEX®  CE



Bursting panel



Flame Arrestor

Explosion Isolation Equipment

- Active Quick Sliding valves
- Passive Barrier valves
- Explosion diverters
- Extinguishing barriers



Explosion Suppression Equipment

- Pressure detection (dynamic/static)
- Infrared detection
- Suppression systems with reusable valves
- Hot Water Advanced Inserting Systems
- ATEX Powder Suppression

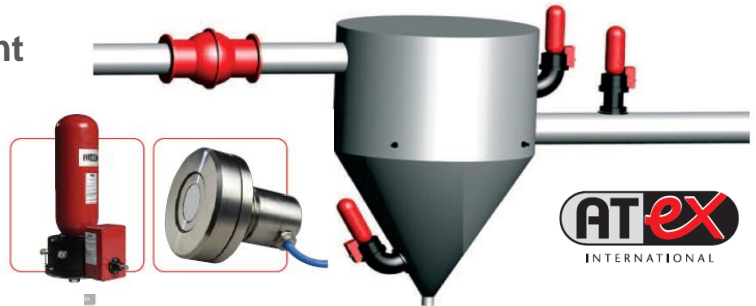

Hosokawa Micron / NUATA MIXER

The newly born, Best seller ,powder mixer
Over 10,000 units of reference worldwide

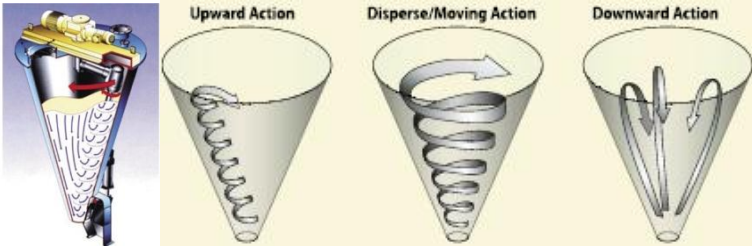

Process Technologies for Tomorrow

HOSOKAWA MICRON CORPORATION

Hosokawa Micron / Grinding Machines

Hammer Mill, Feather Mill / Coarse particle

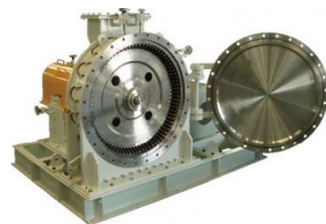

Many Type of machines for fine and ultra fine material



บริษัท เทอร์เรค คอร์ปอเรชั่น จำกัด



Therac Corporation Ltd. www.thereccorp.com

Tel ☎ (662) 893 9003-4 Fax : (662) 893 9005

88 Soi Karnjanapisek 4/2 Karnjanapisek Rd. Bangbon Bangkok 10150 Thailand

General product TRTT02 / 2016